



NTSC U/C

PlayStation™



ESPN®



espn2™

EXtreme Games™

KIDS TO ADULTS



CONTENT RATED BY ESRB

SCUS-94503
94503

SONY



COMPUTER ENTERTAINMENT™

WARNING: READ BEFORE USING YOUR PlayStation™ GAME CONSOLE.

A very small percentage of individuals may experience epileptic seizures when exposed to certain light patterns or flashing lights. Exposure to certain patterns or backgrounds on a television screen or while playing video games, including games played on the PlayStation game console, may induce an epileptic seizure in these individuals. Certain conditions may induce previously undetected epileptic symptoms even in persons who have no history of prior seizures or epilepsy. If you, or anyone in your family, has an epileptic condition, consult your physician prior to playing. If you experience any of the following symptoms while playing a video game – dizziness, altered vision, eye or muscle twitches, loss of awareness, disorientation, any involuntary movement, or convulsions – IMMEDIATELY discontinue use and consult your physician before resuming play.

WARNING TO OWNERS OF PROJECTION TELEVISIONS:

Do not connect your PlayStation game console to a projection TV without first consulting the user manual for your projection TV, unless it is of the LCD type. Otherwise, it may permanently damage your TV screen.

HANDLING YOUR PlayStation™ DISC:

This compact disc is intended for use only with the PlayStation™ game console.

Do not bend it, crush it or submerge it in liquids.

Do not leave it in direct sunlight or near a radiator or other source of heat.

Be sure to take an occasional rest break during extended play.

Keep this compact disc clean. Always hold the disc by the edges and keep it in its protective case when not in use.

Clean the disc with a lint-free, soft, dry cloth, wiping in straight lines from center to outer edge. Never use solvents or abrasive cleaners.

HINT LINE

Hints are available:

Within the US: **1-900-933-SONY** (1-900-933-7669)
\$0.95 per minute pre-recorded information
\$1.15 per minute live representative assistance
\$4.95 for mailed out tips

Within Canada: **1-900-451-5757**
\$1.25 per minute (US Dollars)

For US callers, game counselors are available Monday-Friday, 8AM-6PM, Pacific Standard Time. Automated support is available 24 hours a day, 7 days a week.

In Canada, automated support is available 24 hours a day, 7 days a week. Live support is not available at this time.

This hint line supports games produced by Sony Computer Entertainment America and Psygnosis Limited. No hints will be given on our Consumer Service Line. Callers under 18 years of age, please obtain permission from a parent or guardian before calling. This service requires a touch-tone phone.

CONSUMER SERVICE/TECHNICAL SUPPORT/ORDER LINE

1-800-345-SONY
(1-800-345-7669)

Call this number for help with technical support, installation or general questions regarding the PlayStation™ game console and its peripherals. Representatives are available Monday-Friday, 8AM-6PM Pacific Standard Time.

SONY ONLINE <http://www.sony.com>

Our news is always hot! Visit our website and find out what's happening at Sony – new titles, new products and fresh tidbits about the Sony PlayStation™ game console.

TABLE OF CONTENTS

PLAYSTATION SETUP	2
BE EXTREME	3
CONTROL SUMMARY	4
CHOOSE SETTINGS	5
MAIN ROOM	7
EQUIPMENT ROOM	9
EQUIPMENT INVENTORY	11
Controls	12
Extreme Lean	13
Obstacles	13
Maneuvering	13
Gates	14
Wiping Out	14
Strength Meter	15
Fighting	15
Pause Menu	16
EXTREME SEASON ACTION	16
Name Entry	17
Memory Card	17
CREDITS	18 & 19

PLAYSTATION SET-UP

Console

Top View

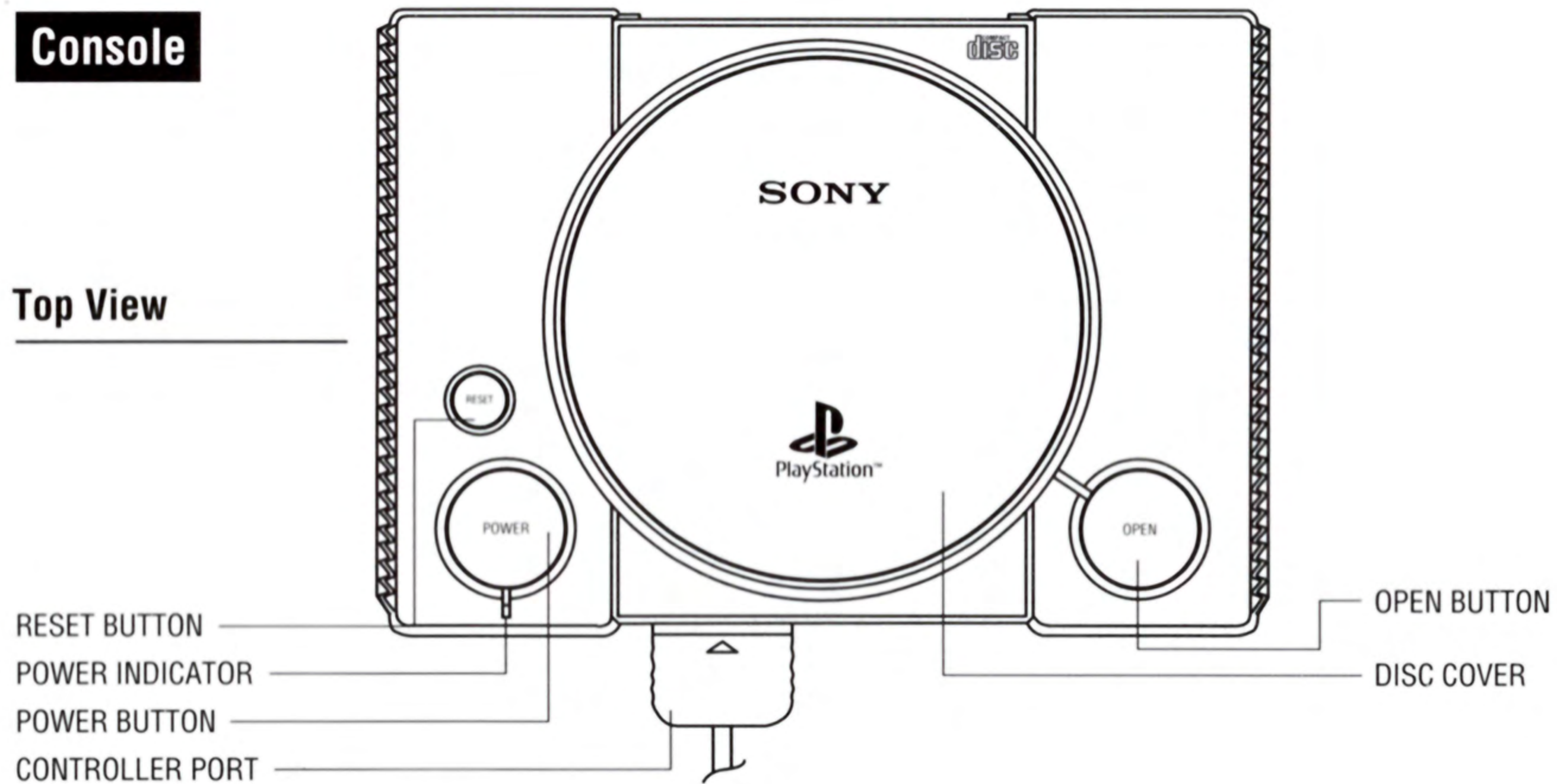

Front View

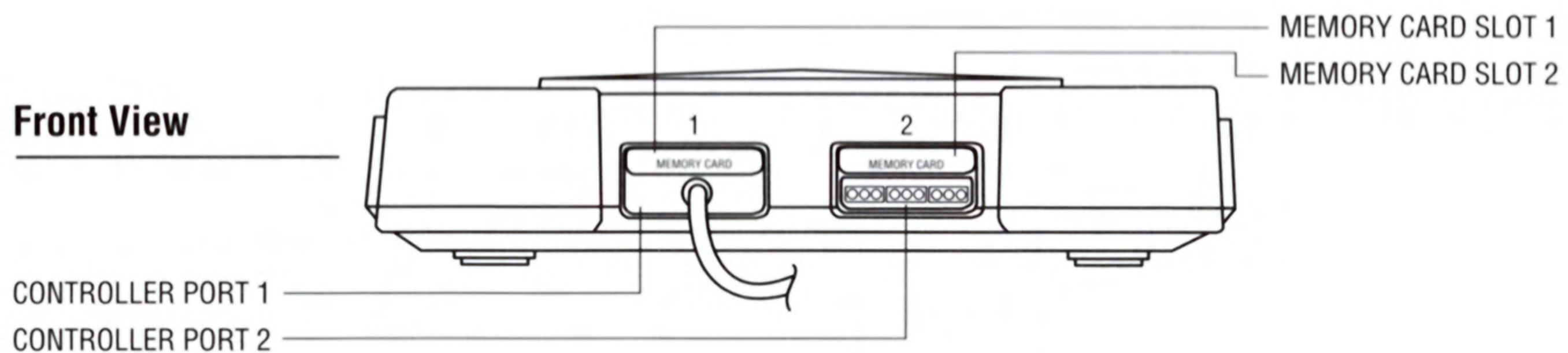

Set up your PlayStation™ game console according to the instructions in its Instruction Manual. Make sure the power is off before inserting or removing a compact disc. Insert the ESPN Extreme Games disc and close the CD door. Insert game controllers and turn on the PlayStation™ game console. Follow on-screen instructions to start a game.

BE EXTREME

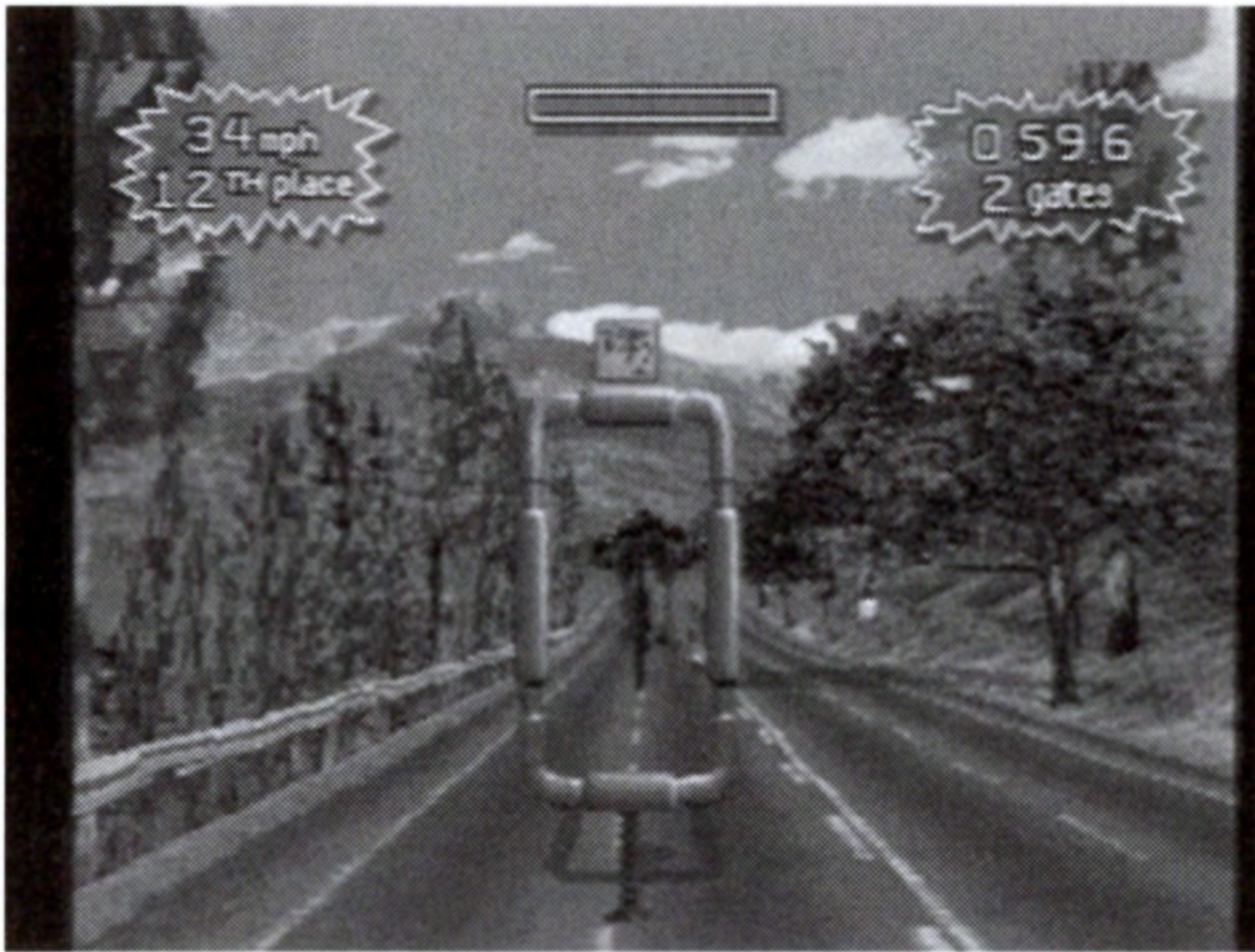

ESPN's Extreme Games is the only game that offers you the chance to race with all the most radical human-powered speed equipment: street luge, in-line skates, skateboard and mountain bike. The courses are totally rigorous, and your opponents don't have any problem with punching and kicking you if you let them get close enough. You've got to be ready to do anything to get to the top of the standings in the grueling season that lies ahead. Choose your equipment carefully, and always make sure to upgrade when you earn enough cash. Some vehicles are faster than others, and some are more stable. Only you will know the best way to make it to the finish line ahead of the pack. It's takes skill, tenacity, and above all the will to win. The more extreme you are, the better off you'll be.

Controller

Front View

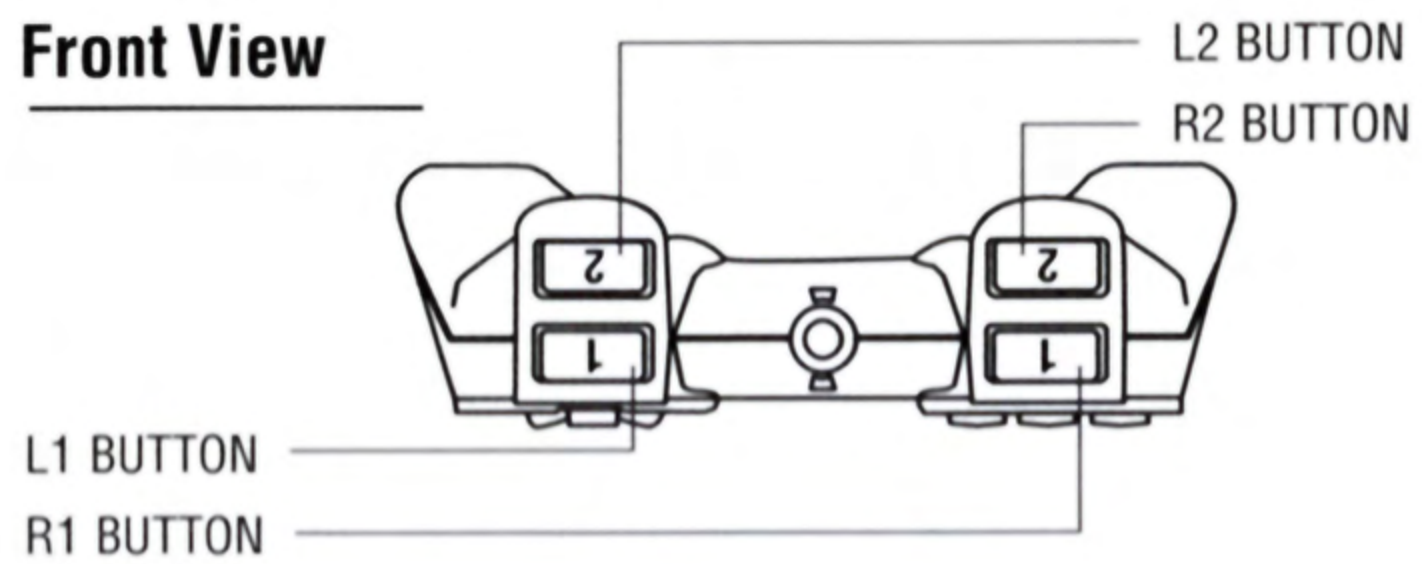

Mouse

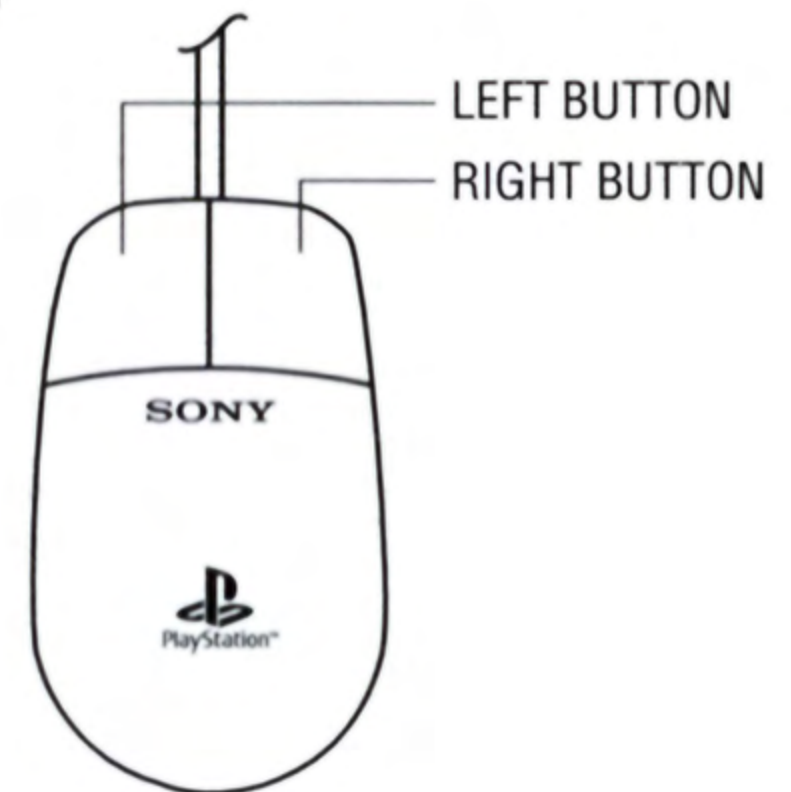

Top View

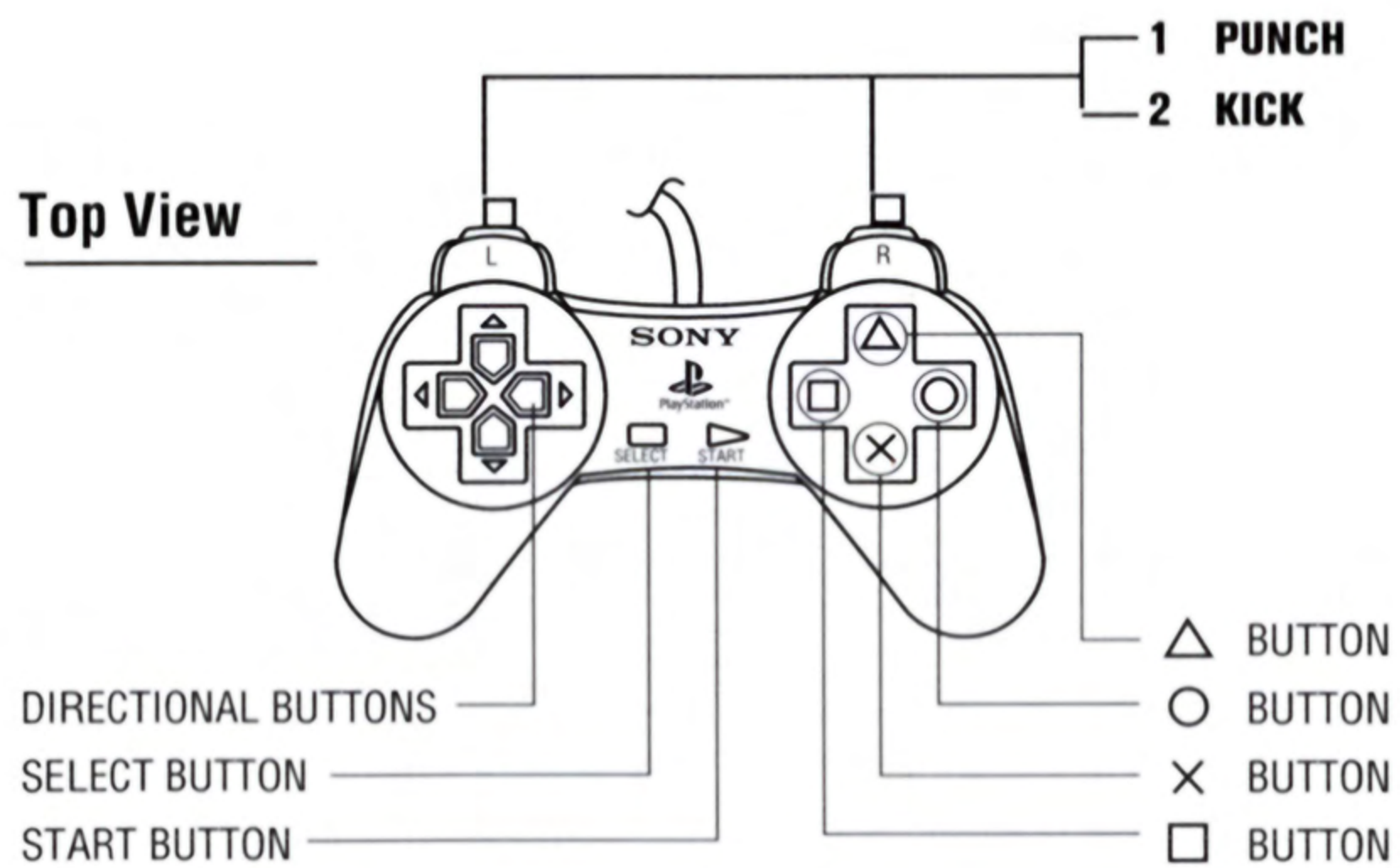

CHOOSE SETTINGS



Use the **up/down** directional arrows to move the highlight up and down the Choose Settings menu.

Use the **left/right** directional arrows (or the control buttons) to cycle through the options on the highlighted line. The option that appears on the list is the selected option.

To continue on to the next screen, press **Start**.

One Player/Two Players

You need two controllers for a two player game. The player with the controller plugged into the jack on the right side of the PlayStation is Player Two.



PLAYER ONE

PLAYER TWO

In a Two Player game, the top portion of the screen displays the race of Player One. The bottom portion displays the race of Player Two.

New Season/Continue Season/Exhibition

A Season is a 12 race competition against 15 opponents. During the season, all the racers are ranked from 1 to 16 according to their performances. Your job is to be at the top of the standings after the 12th race. A season that starts as a Two Player season cannot be changed to a One Player Season, and vice versa.

Exhibition races are practice races, which are not recorded in any season standings. Use Exhibition mode to get a feel for the different vehicles on the different levels.

Easy/Medium/Difficult/Extreme

You should probably start out at Medium or Easy, and then move on to higher levels. This game is challenging even on the Easy level, and it'll take a long time before you get good enough to win the Extreme Season Championship.

Sound Volume

The sound volume slider allows you to adjust the volume of the course sound effects. Use the Directional Arrows to adjust the slider—left to decrease the volume and right to increase the volume.

Music Volume

The music volume slider allows you to adjust the volume of the background music. Use the Directional Arrows to adjust the slider—left to decrease the volume and right to increase the volume.

Video On/Off

Video clips before and after each race feature ESPN's Suzy Kolber, who introduces the race courses and gives her opinion on your performance. If Suzy gets on your case about not being very skillful, don't take it too personally. She'll more than make up for her chiding words once you start finishing in the front of the pack. If Suzy gets on your nerves, simply turn the video off.

MAIN ROOM

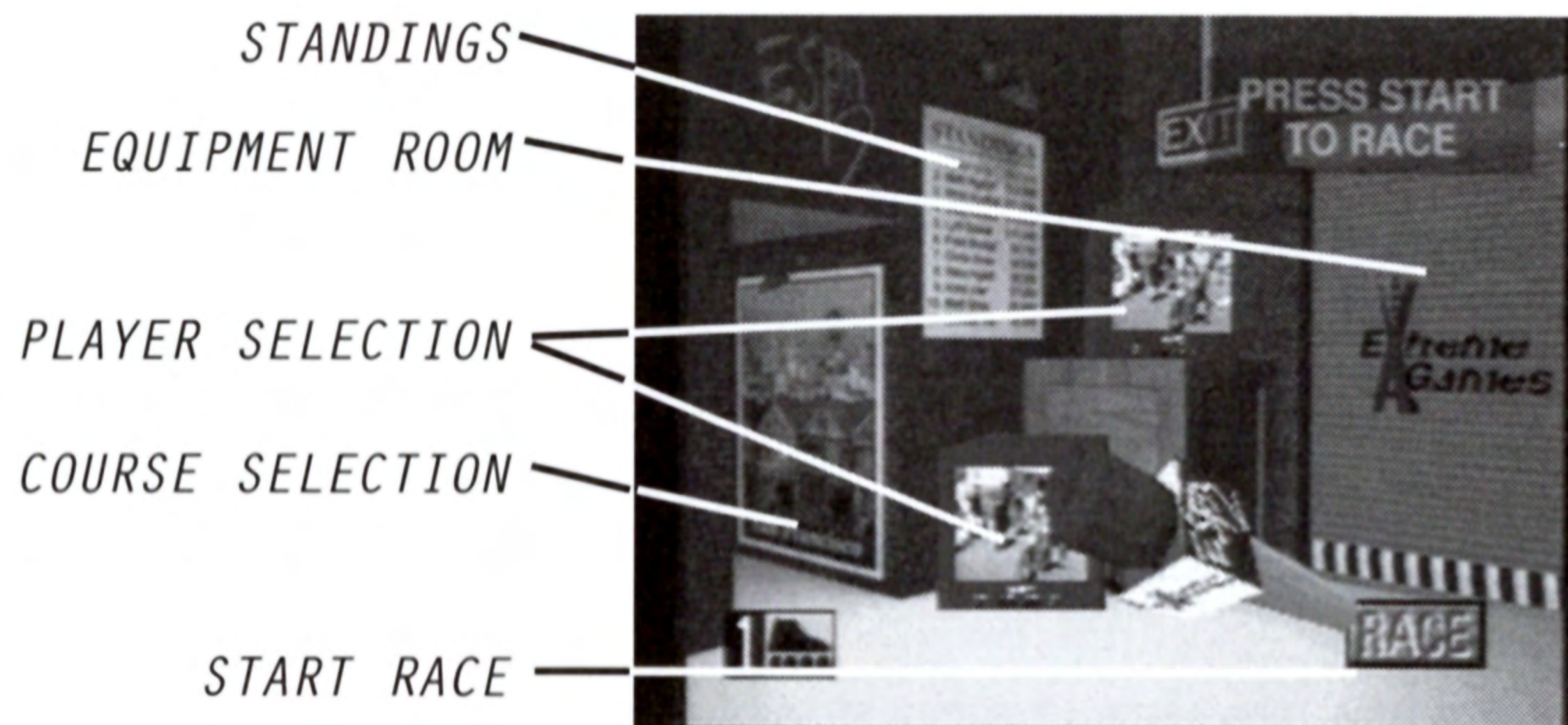

Use the Directional Arrows to move the microphone icon to the different options.

To select the option, press **any control button**.

Course Selection

You can pick from any of the five courses. Simply move the mike to the course poster and press a button. Use any button to cycle through the courses.

Player Selection

The Player selection allows you to pick which one of the sixteen player characters you want to be. TV 1 is the Player One selector. TV2 is where you select Player Two, and is available only when a two player game is selected. Use the **left/right** directional arrows to highlight the character you want to be.

Equipment Room

This selection takes you into the equipment room, where you decide which of the four vehicles you'll use in the upcoming race. Also, you need to come here to upgrade your equipment with your available funds.

See page below for complete instructions for the Equipment Room.

Exit to Sign In

Select this option to return to the Sign In area, where you can start all over again.

Standings

This selection is available only during Season competition. It shows all the racers ranked from 1-16 and gives their placement in each of the individual races. Your racer is the one highlighted.

Start Race

Select this option to go directly to the race course.

EQUIPMENT ROOM

PLAYER SELECTION
EQUIPMENT SELECTION
INVENTORY
COURSE SELECTION
MAIN ROOM



Use the Directional Arrows to cycle through all the available choices. When you select one of the four colored equipment icons, press any control button to highlight that icon.

To begin the race, press **Start**.

To return to the Main Room, press the directional arrows to open the door and then press any control button

Equipment Icons

There are four pieces of extreme equipment, each one associated with a colored icon: mountain bike (red), skateboard (blue), street luge (green), in-line skates (yellow).

The piece of equipment used in the previous race is automatically selected for use in the next race, unless you decide to change it by highlighting another. The piece of equipment represented by the icon last highlighted in the Equipment room is the one you will use for the next race.

Equipment Catalogue



After you highlight a piece of equipment, you can upgrade to a faster, more expensive model by going to the Equipment Catalogue.

The catalogue begins with the model you presently own of the currently selected item. To page forward through the catalogue, press the right directional arrow. A picture of each model appears on the right page, and a description (including the price) appears on the left page. If you don't have enough dough for the model showing, the catalogue lets you know that.

To upgrade to a new model, press **Select**.

Customizing Your Opponents

In both One Player and Two Player games, you can decide which vehicles your opponents will use, or you can eliminate them altogether.

The TV Icon is automatically set to Player One. To switch to CPU (Computer Processing Unit) click on the TV Icon. In a Two Player Game, click on the TV icon twice to switch to CPU.

With the CPU opponents activated, the red, blue, green, and yellow equipment icons now govern the computer-controlled racers. Initially, all four icons are illuminated. Turn off one or more of the icons to eliminate those vehicles from the race.

For Example, if you want to race only against mountain bikers and skateboarders, turn off in-line skates and street-luge. Now, half the racers will ride mountain bikes and half will ride skateboards. If you want to race against only one piece of equipment, turn off the other three.

If you want to race solo, or only against another human opponent, turn off all the equipment icons.

EQUIPMENT INVENTORY



The Equipment Inventory page shows you all four of your current extreme equipment models. Use this as a quick reference.

EXTREME ACTION



All four vehicles use the same basic controls, though the size and shape of a particular vehicle can affect usefulness of one of more of the controls. For example, the crouch command is not active when you're on the street luge, since you're already down as low as you can be. But the street luge is faster than the other vehicles.

Controls

Steer	Directional Arrows Left/Right
Accelerate	X Button
Decelerate	▲ Button
Jump	● Button (except street luge)
Crouch	■ Button (except street luge)
Triggers 1	Punch Left/Right (except mountain bike)
Triggers 2	Kick Left/Right (except street luge)

Extreme Lean

To get the most out of your vehicle, you can execute an extreme lean. This gives you the tightest possible turn.

Extreme Lean Press the Direction Pad Left/Right **and** Down

Obstacles

Dozens of different obstacles on the five different courses threaten to slow you down and knock you off your vehicle. Each obstacle has its own mass and stability, which affects the skater or rider when he or she hits it. Some will knock you down easily, others require you hit to it head on.

The *Difficulty* level selected on the Choose Settings screen determines how many obstacles you'll find on the race courses. The lower difficulty levels call for fewer obstacles, and the higher ones call for more.

Maneuvering

Certain maneuvers enable you to avoid or glance off obstacles.

Jumping—You can jump over certain obstacles, depending on which vehicle you're using. For example, when you're roller-blading, you can jump over hay bales and barrels if you time your jump correctly.

The truly extreme can jump off the top of obstacles and perform a special acrobatic move.

Crouching—Look for obstacles that threaten to take your head off and crouch as you approach them.

Leaning and Extreme Leaning—If you're about to slam into an obstacle, try to avoid it. If you happen to be leaning when you hit the obstacle, your chances of glancing off it and remaining on your vehicle are increased.

Gates



When you pass through a gate, you earn scoring points. At the end of each race, you'll see how many gates you made and how many you missed. If you make all the gates on a course, you automatically go to a special cash course, which consists bonus of \$5 and \$10 gates.

The three different colored gates each have their own purpose. The green gates give you cash. The yellow gates earn you season points. The blue gates create special effects or open secret passages.

Wiping Out



Whenever you hit an obstacle you lose speed and, therefore, time. If you hit something hard enough, you'll wipe out. When you wipe out, it takes time to get back on your vehicle and begin moving again. Obviously, you want to avoid wiping out, since that enables competitors behind you to catch up.

Strength Meter

At the top of the race screen you'll find the strength meter. Each time you hit an obstacle, wipe out, or get punched or kicked by another racer, you lose some stamina. Also, you lose stamina when you are peddling, skating, or pushing off. The less stamina you have, the easier it is for you to get knocked off your vehicle.

To increase your stamina, ride or skate without hitting anything, or skate in a crouch. The longer and faster you go without hitting something or being struck by your competitors, the more stamina you'll regain.

Fighting



Fighting is an unavoidable part of Extreme Games, and it's a good idea to get good at it, if only to defend yourself. Punching or Kicking other racers tends to slow you down, so it's advisable not to overuse the fighting triggers.

By the same token, since it's your goal to finish as high in the field as possible, you might find it useful to knock other racers off their vehicles so as to get past them and improve your position.

Use your discretion to find a balance between out-racing your competitors and fighting your way past them. We recommend not fighting with the racers at the back of the pack, since your goal is to get to the front of the pack.

Pause Menu



At any time during the race, you can press **Start** to pause the action. A menu appears, offering the following options. Press the Up/Down Directional Arrows to select the different pause options.

SOUND/MUSIC VOLUME: Adjust the Sound or Music volume with Left/Right Directional Arrow inputs.

EXIT: Highlight this option and press X to return to the Main Room, thereby canceling the race. If you cancel a race, you'll automatically be placed last.

RESUME: Highlight this option and press X to resume the race.

EXTREME SEASON



The racing Season consists of 12 races on alternating courses. You can change and upgrade your vehicles between races, but you can't change courses—the order is predetermined, just like on a professional circuit.

Name Entry



You'll need to enter a three letter name that identifies your racer for that particular season. At the end of race, before you shut down, the computer will show you a password. Make sure to write down your password. You'll need to enter it when you resume the season.

Use Memory Card



If you want to save a season on the memory card, you must indicate YES when you're prompted at the beginning of a season.

CREDITS

LEAD PROGRAMMER

Mark Lyons

PROGRAMMERS

Bob Gordon

David Brickhill

LEAD ARTIST

Joe Brisbois

ARTISTS

Emmanual Valdez, Alesia Howard, Bert Huntsinger,
Scott Atkins, Quinn Kaneko, Warren Atkins, Katie Roe

SOUND

Rex Baca

VIDEO

Joe Hight

MUSIC

Wintermoon Music

EXECUTIVE PRODUCER

Chris Whaley

ASSISTANT PRODUCER

Dennis Quinn

TOOLS PROGRAMMING

Bill Long, Phil Weeks

MARKETING

Kelly Ryan, Craig Ostrander, Peter Dille

MANUAL AND LAYOUT

T.S. Flanagan

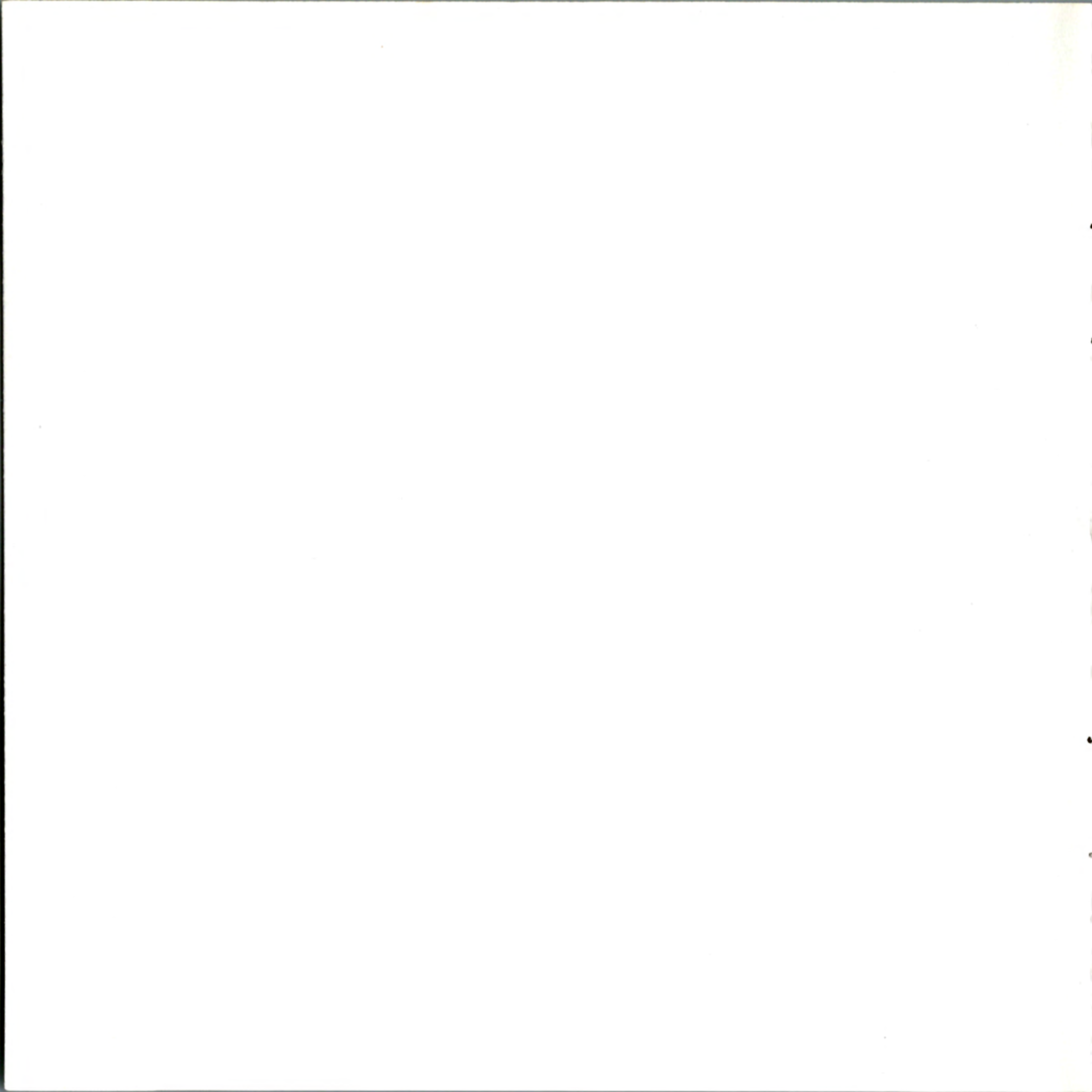

Software Warranty

Sony Computer Entertainment America (SCEA) warrants to the original purchaser of this SCEA product that this Software is free from defects in material and workmanship for a period of ninety (90) days from the date of purchase. SCEA agrees for a period of ninety (90) days to either repair or replace, at its option, the SCEA product. You must call 1-800-345-SONY to receive instructions to obtain repair/replacement services.

This warranty shall not be applicable and shall be void if the defect in the SCEA product has arisen through abuse, unreasonable use, mistreatment or neglect. THIS WARRANTY IS IN LIEU OF ALL OTHER WARRANTIES AND NO OTHER REPRESENTATIONS OR CLAIMS OF ANY NATURE SHALL BE BINDING ON OR OBLIGATE SCEA. ANY IMPLIED WARRANTIES APPLICABLE TO THIS SOFTWARE PRODUCT, INCLUDING WARRANTIES OF MERCHANTABILITY AND FITNESS FOR A PARTICULAR PURPOSE, ARE LIMITED TO THE NINETY (90) DAY PERIOD DESCRIBED ABOVE. IN NO EVENT WILL SCEA BE LIABLE FOR INCIDENTAL OR CONSEQUENTIAL DAMAGES RESULTING FROM POSSESSION, USE OR MALFUNCTION OF THE SCEA SOFTWARE PRODUCT.

Some states do not allow limitations as to how long an implied warranty lasts and/or exclusions or limitations of consequential damages, so the above limitations and/or exclusions of liability may not apply to you. This warranty gives you specific legal rights, and you may also have other rights which vary from state to state.

Coming Fall
1996

THE MAKERS OF EXTREME GAMES ARE BACK WITH ALL NEW VENUES AND CHALLENGES THAT ARE **2 XTREME**

2 XTREME

2 Xtreme Features

Four Xtreme Sporting venues include a total of 12 new courses

SNOWBOARD in Japan, **INLINE SKATE** in Las Vegas,
MOUNTAIN BIKE in Africa and **SKATEBOARD** in
Los Angeles.

New points system – compete in a season & earn points based on
your finish!

4 types of "Power-up" – Health, Speed, Strength & Jumping

10 INSANE characters with specific strengths and weaknesses

Extreme moves include rail slides and ollie airs on the **SKATEBOARD**
& carves, rail grabs and Japans on the **SNOWBOARD**



2 Xtreme © 1996 Sony Interactive Entertainment Inc. ESPN, ESPN2 and Extreme Games are trademarks of ESPN, Inc. Licensed in conjunction with Names International, Inc. and International Computer Group, Inc. Game © 1995 Sony Interactive Entertainment Inc.

Sony Computer Entertainment logo is a trademark of Sony Corporation. PlayStation and the PlayStation logos are trademarks of Sony Computer Entertainment Inc. The ratings icon is a registered trademark of the Interactive Digital Software Association. Manufactured and printed in the U.S.A. THIS SOFTWARE IS COMPATIBLE WITH PLAYSTATION GAME CONSOLES WITH THE NTSC U/C DESIGNATION. U.S. AND FOREIGN PATENTS PENDING.

